













HomCom Full Size Mattress Wood Slat
Platform Bed Frame

Manual for
Model # 02-0412



WARNING

Manufacturer and seller expressly disclaim any and all liability for personal injury, property damage or loss, whether direct, indirect, or incidental, resulting from the incorrect attachment, improper use, inadequate maintenance, or neglect of this product.



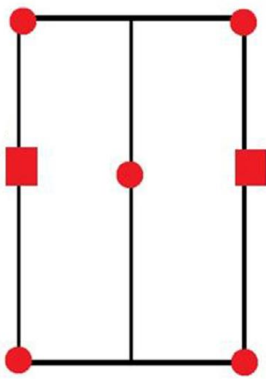
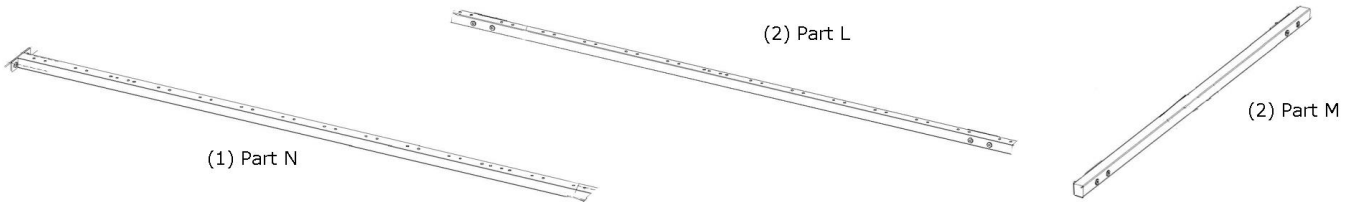

PART LIST		A		B		C		D		E		F		G		H		I		J		K		
			screw	M8X40	24pcs		nut	M8	20pcs		L key	1pc		plastic corner	4pcs		bracket	4pcs		slat	28pcs		T leg	7pcs
			double plastic cap				wrench				single plastic cap	28pcs		double plastic cap	14pcs									



Please note that Part J has a total of (7) pieces, but (5) are circled and (2) are squared.



*See diagram on left

1

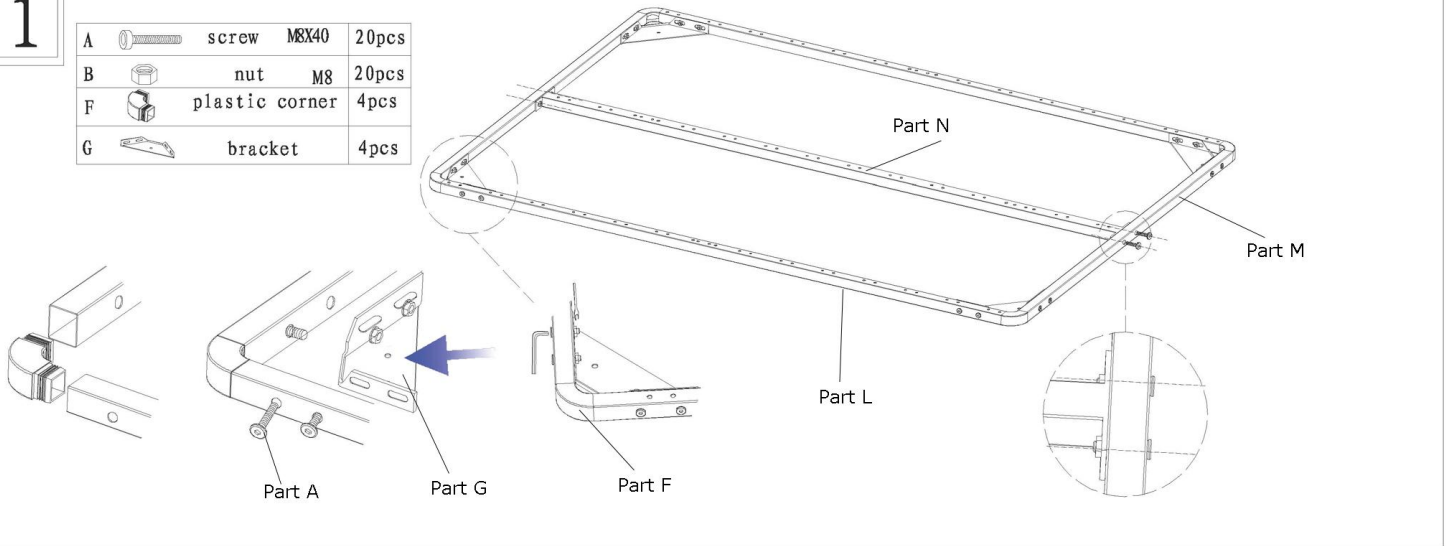
A		screw	M8X40	20pcs
B		nut	M8	20pcs
F		plastic corner		4pcs
G		bracket		4pcs



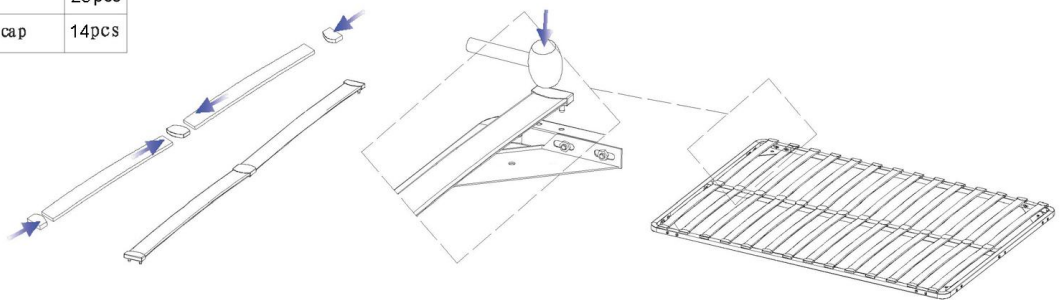

2

D		single plastic cap		28pcs
H		slat		28pcs
K		double plastic cap		14pcs



3

A		screw	M8X40	4 pcs
C		screw	M8X40	4 pcs
J		T leg		6 pcs

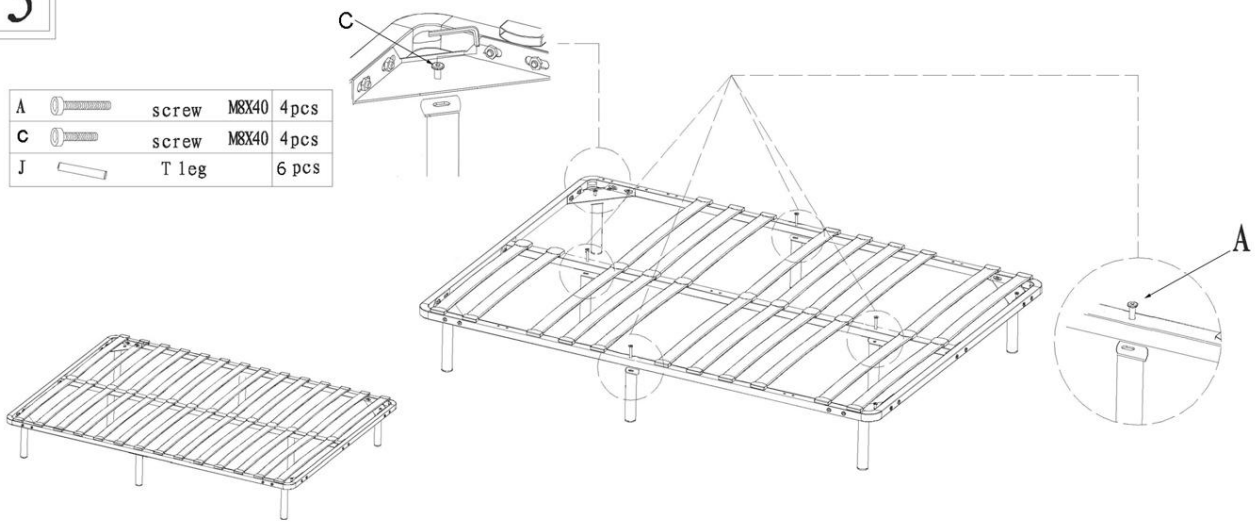

Please call customer service with any questions or concerns regarding this model at 1-877-644-9366